

AP180N03G

N-Channel Power MOSFET

Features

- 30V,180A
- $R_{DS(ON)} = 1.7\text{ m}\Omega$ (Typ.) @ $V_{GS} = 10V$
- $R_{DS(ON)} = 3.2\text{ m}\Omega$ (Typ.) @ $V_{GS} = 4.5V$
- Low Total Gate Charge
- Low Reverse Transfer Capacitance
- Improved dv/dt Capability
- Fast Switching Speed

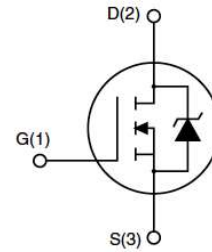

Application

- Load Switch
- PWM Application

Package

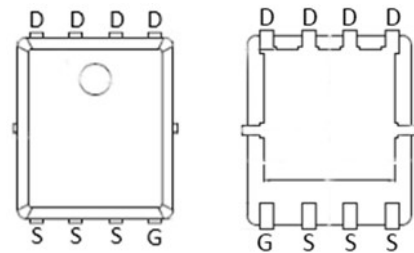

PDFN5X6

Package Marking and Ordering Information

Device Marking	Device	Device Package	Reel Size	Tape width	Quantity (PCS)
180N03G	AP180N03G	PDFN5X6	13 inch	-	5000

ABSOLUTE MAXIMUM RATINGS ($T_a=25^\circ\text{C}$ unless otherwise noted)

Parameter	Symbol	Value	Unit
Drain-Source Voltage	V_{DS}	30	V
Gate-Source Voltage	V_{GS}	± 20	V
Continuous Drain Current ($T_a = 25^\circ\text{C}$)	I_D	180	A
Continuous Drain Current ($T_a = 100^\circ\text{C}$)	I_D	115	A
Pulsed Drain Current ⁽¹⁾	I_{DM}	720	A
Singel Pulsed Avalanche Energy ⁽²⁾	E_{AS}	306	mJ
Power Dissipation	P_D	130	W
Thermal Resistance, Junction to Case ⁽⁴⁾	$R_{\theta JC}$	0.97	$^\circ\text{C}/\text{W}$
Junction Temperature	T_J	150	$^\circ\text{C}$
Storage Temperature	T_{STG}	-55~ +150	$^\circ\text{C}$

AP180N03G
N-Channel Power MOSFET
Electrical Characteristics ($T_C=25^\circ\text{C}$ unless otherwise specified)

Parameter	Symbol	Test Conditions	Value			Unit
			Min.	Typ.	Max.	
Static						
Drain-Source Breakdown Voltage	$V_{(BR)DSS}$	$V_{GS} = 0V, I_D = 250\mu A$	30	--	--	V
Zero Gate Voltage Drain Current	I_{DSS}	$V_{DS} = 30V, V_{GS} = 0V, T_J = 25^\circ\text{C}$	--	--	1	μA
		$V_{DS} = 30V, V_{GS} = 0V, T_J = 55^\circ\text{C}$	--	--	5	
Gate-Source Leakage	I_{GSS}	$V_{GS} = \pm 20V$	--	--	± 100	nA
Gate-Source Threshold Voltage	$V_{GS(th)}$	$V_{DS} = V_{GS}, I_D = 250\mu A$	1	1.7	2.4	V
Drain-Source On-Resistance (Note3)	$R_{DS(on)}$	$V_{GS} = 10V, I_D = 30A$	--	1.7	2.1	$m\Omega$
		$V_{GS} = 4.5V, I_D = 20A$	--	3.2	4.0	$m\Omega$
Forward Transconductance (Note3)	g_{fs}	$V_{DS} = 10V, I_D = 20A$	20.8	--	--	S
Dynamic						
Input Capacitance	C_{iss}	$V_{GS} = 0V,$ $V_{DS} = 15V,$ $f = 1.0\text{MHz}$	--	4300	--	pF
Output Capacitance	C_{oss}		--	720	--	
Reverse Transfer Capacitance	C_{rss}		--	420	--	
Total Gate Charge	Q_g	$V_{DD} = 15V, I_D = 20A,$ $V_{GS} = 10V$	--	70	--	nC
Gate-Source Charge	Q_{gs}		--	10	--	
Gate-Drain Charge	Q_{gd}		--	15	--	
Turn-on Delay Time	$t_{d(on)}$	$V_{DD} = 15V, R_G = 3\Omega$	--	10	--	ns
Turn-on Rise Time	t_r		--	6.5	--	
Turn-off Delay Time	$t_{d(off)}$		--	75	--	
Turn-off Fall Time	t_f		--	18	--	
Drain-Source Body Diode Characteristics						
Continuous Body Diode Current	I_S	$T_C = 25^\circ\text{C}$	--	--	150	A
Pulsed Diode Forward Current	I_{SM}		--	--	720	
Body Diode Voltage	V_{SD}	$T_J = 25^\circ\text{C}, I_{SD} = 30A, V_{GS} = 0V$	--	--	1.2	V
Reverse Recovery Time	t_{rr}	$I_F = 20A,$ $di_F/dt = 100A/\mu s$	--	30	--	ns
Reverse Recovery Charge	Q_{rr}		--	15	--	nC

Notes:

1. Repetitive Rating: pulse width limited by maximum junction temperature
2. EAS Condition: $T_J=25^\circ\text{C}, V_{DD}=15V, R_G=25\Omega, L=0.5\text{mH}$
3. Pulse Test: pulse width $\leq 300\mu s$, duty cycle $\leq 2\%$
4. Surface Mounted on FR4 Board, $t \leq 10$ sec

AP180N03G

N-Channel Power MOSFET

Typical Performance Characteristics

Figure 1: Output Characteristics

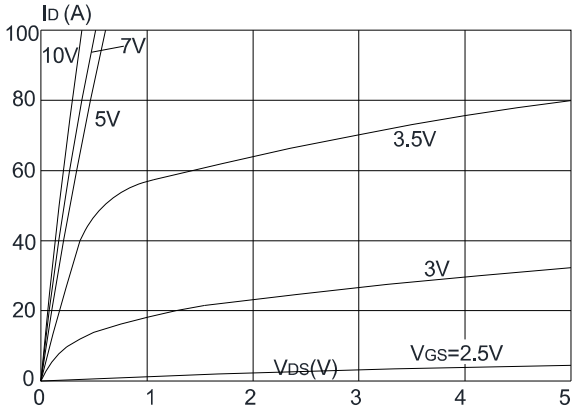

Figure 2: Typical Transfer Characteristics

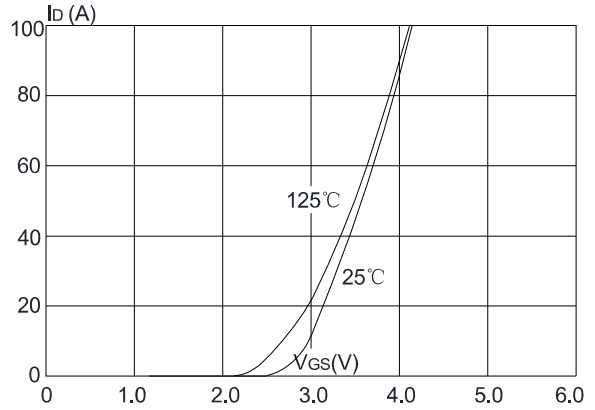

Figure 3: On-resistance vs. Drain Current

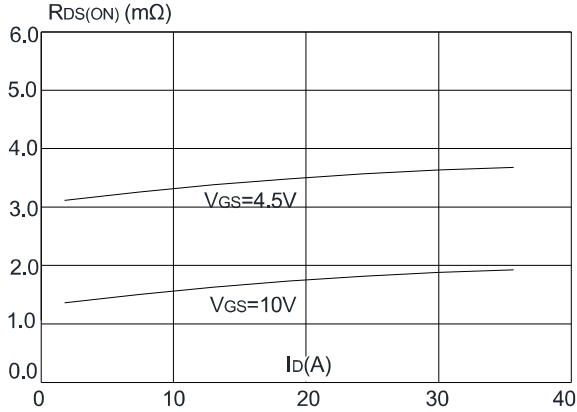

Figure 4: Body Diode Characteristics

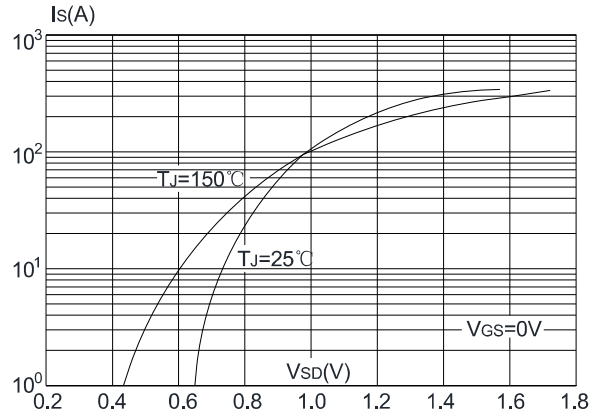

Figure 5: Gate Charge Characteristics

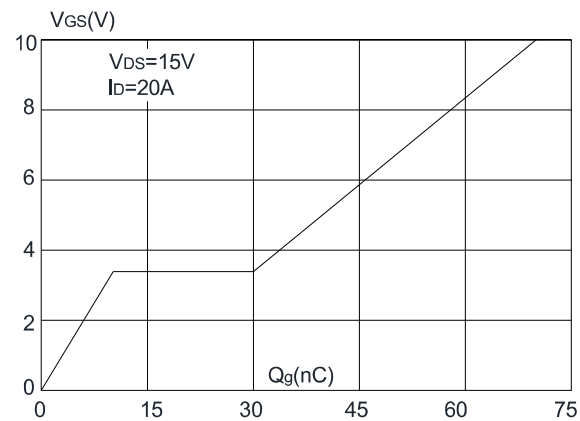
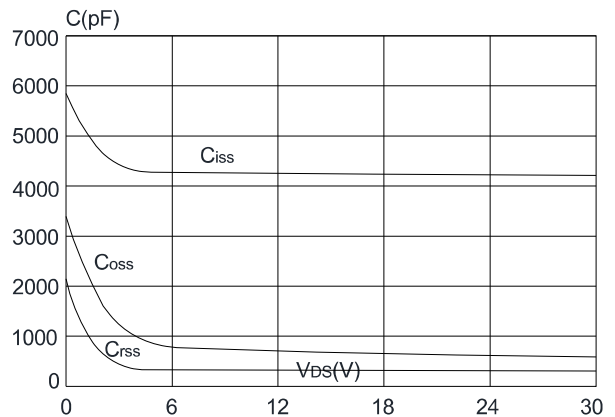

Figure 6: Capacitance Characteristics



AP180N03G

N-Channel Power MOSFET

Figure 7: Normalized Breakdown Voltage vs. Junction Temperature

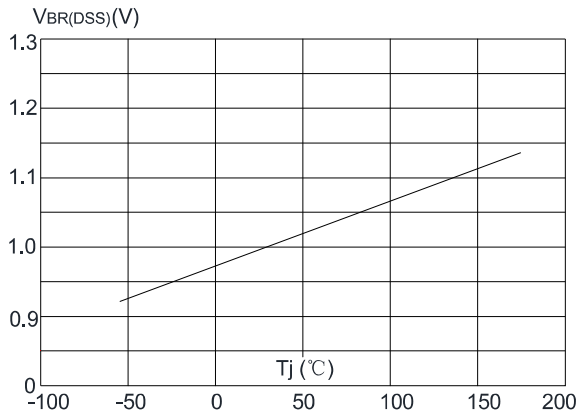

Figure 8: Normalized on Resistance vs. Junction Temperature

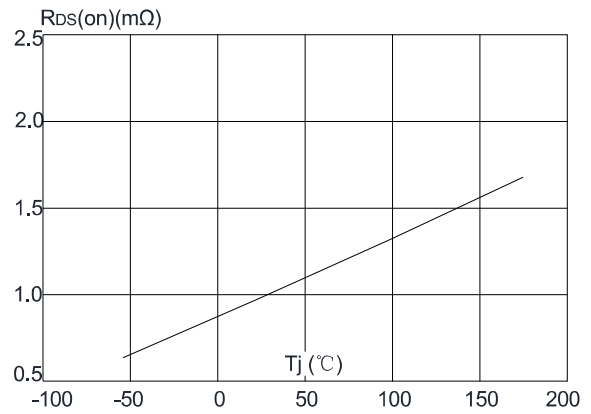

Figure 9: Maximum Safe Operating Area

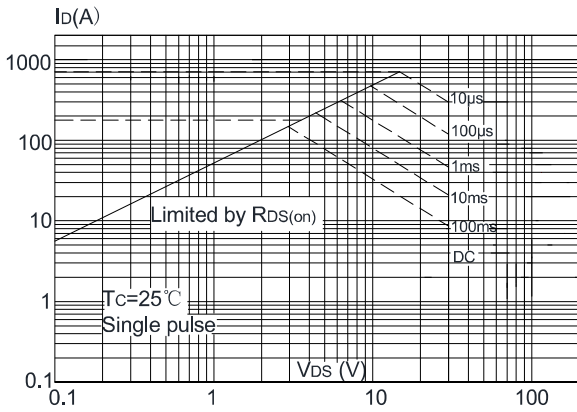

Figure 10: Maximum Continuous Drain Current vs. Case Temperature

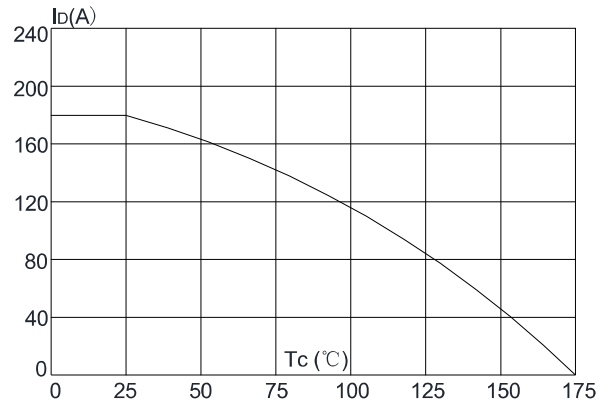
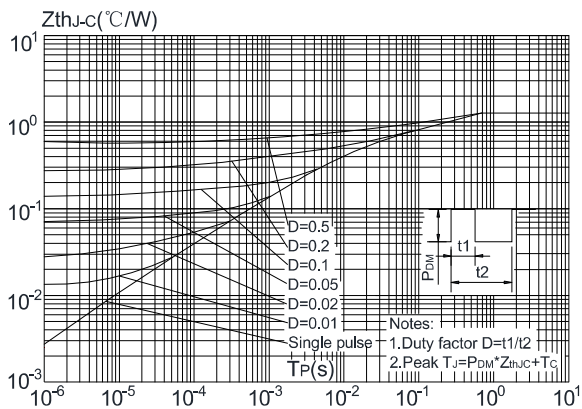

Figure.11: Maximum Effective Transient Thermal Impedance, Junction-to-Case



N-Channel Power MOSFET

Figure 1: Gate Charge Test Circuit and Waveform

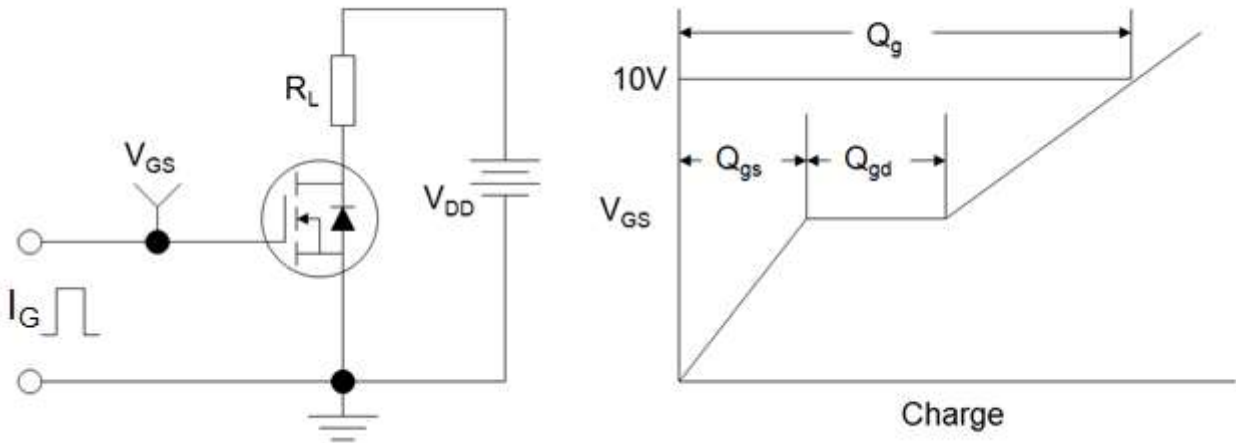

Figure 2: Resistive Switching Test Circuit and Waveform

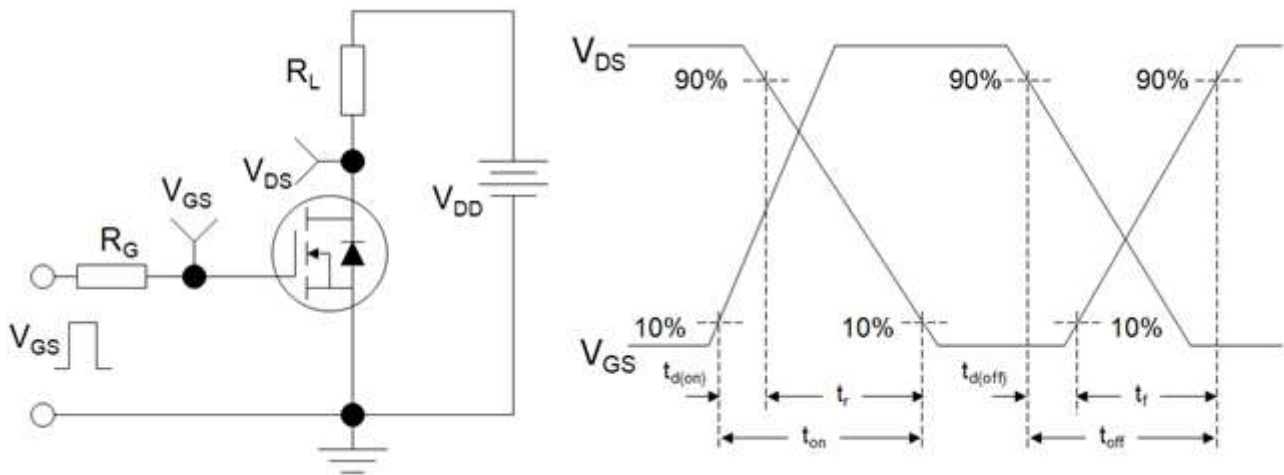
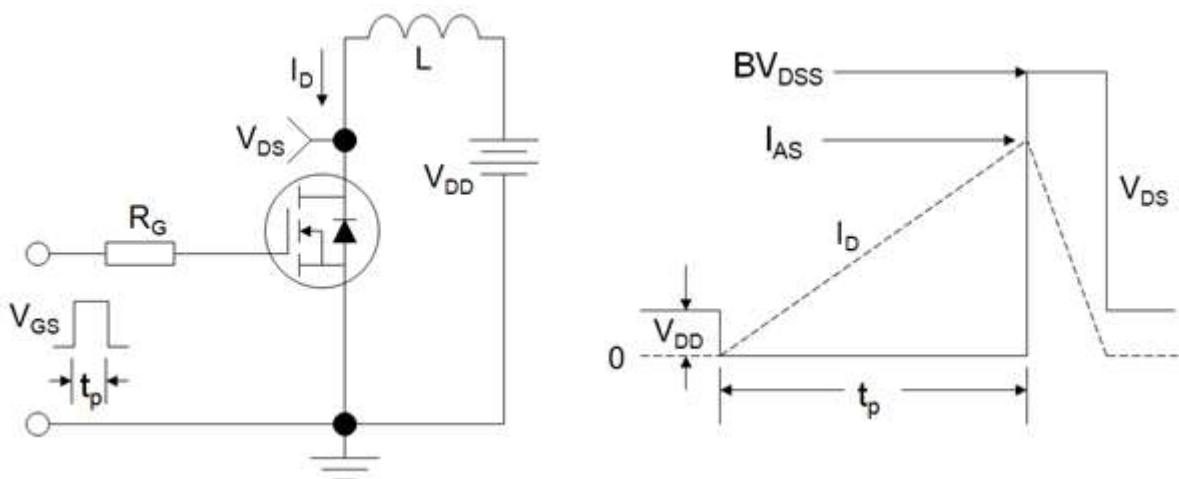

Figure 3: Unclamped Inductive Switching Test Circuit and Waveform



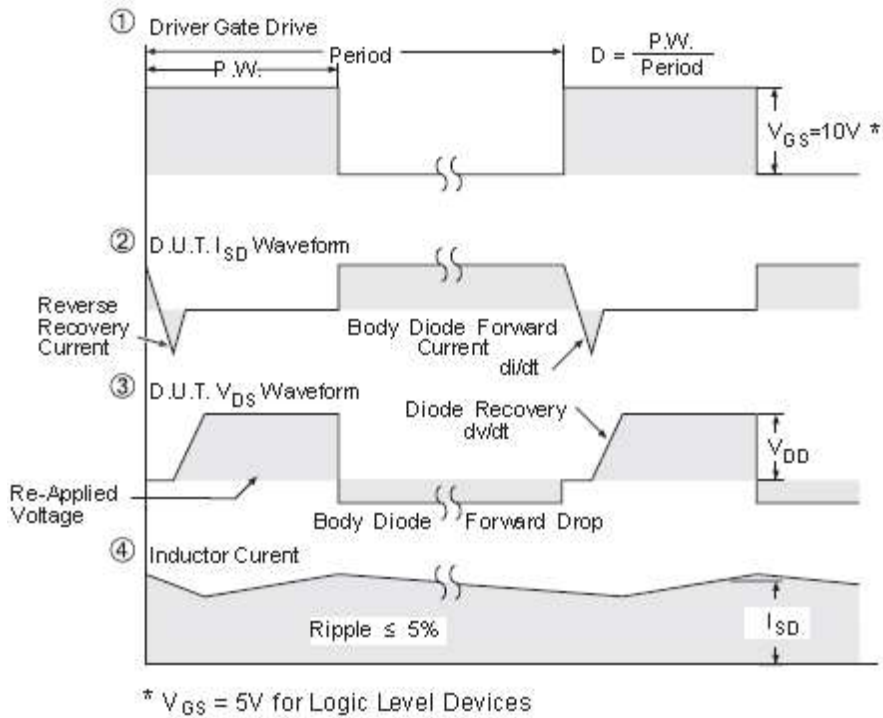
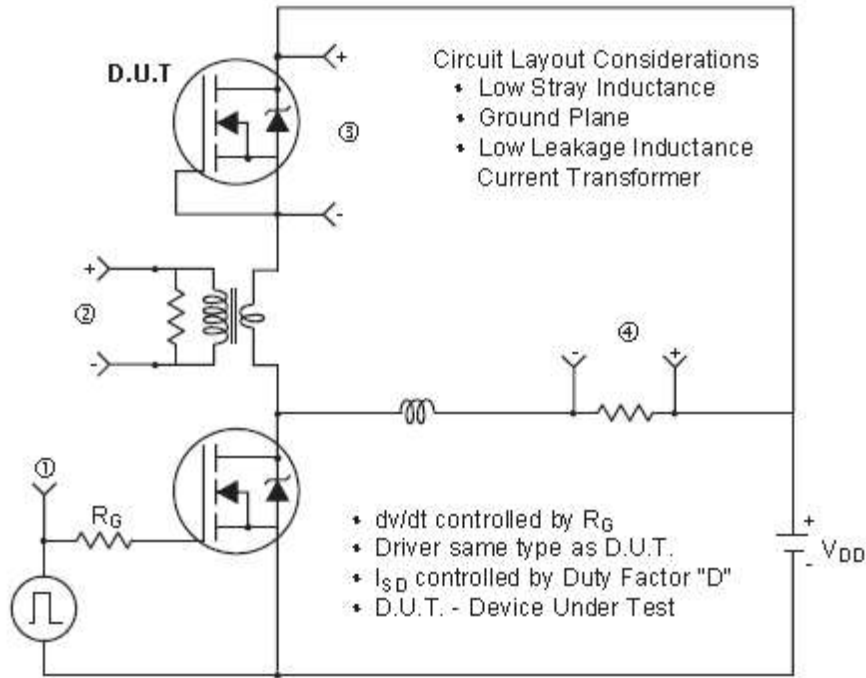
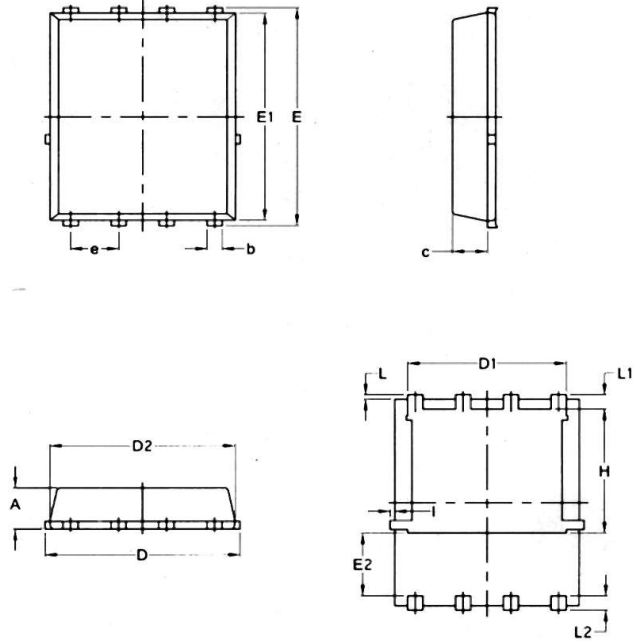

Figure 4: Peak Diode Recovery dv/dt Test Circuit & Waveforms (For N-channel)

AP180N03G

N-Channel Power MOSFET

Package Mechanical Data



PDFN5X6

SYMBOL	COMMON			
	MM		INCH	
	MIN.	MAX.	MIN.	MAX.
A	1.03	1.17	0.0406	0.0461
b	0.34	0.48	0.0134	0.0189
c	0.824	0.970	0.0324	0.0382
D	4.80	5.40	0.1890	0.2126
D1	4.11	4.31	0.1618	0.1697
D2	4.80	5.00	0.1890	0.1969
E	5.95	6.15	0.2343	0.2421
E1	5.65	5.85	0.2224	0.2303
E2	1.60	—	0.0630	—
e	1.27 BSC		0.05 BSC	
L	0.05	0.25	0.0020	0.0098
L1	0.38	0.50	0.0150	0.0197
L2	0.38	0.50	0.0150	0.0197
H	3.30	3.50	0.1299	0.1378
I	—	0.18	—	0.0070

AP180N03G**N-Channel Power MOSFET**

Information furnished in this document is believed to be accurate and reliable. However, Shenzhen All Power Semiconductor Co.,Ltd assumes no responsibility for the consequences of use without consideration for such information nor use beyond it.

Information mentioned in this document is subject to change without notice, apart from that when an agreement is signed, All Power complies with the agreement.

Products and information provided in this document have no infringement of patents. All Power assumes no responsibility for any infringement of other rights of third parties which may result from the use of such products and information.

This document supersedes and replaces all information previously supplied.